

X45 M35 Basic Pro

Art. n° 80.60.103

Système de tri de déchets avec système de guidage des cadres

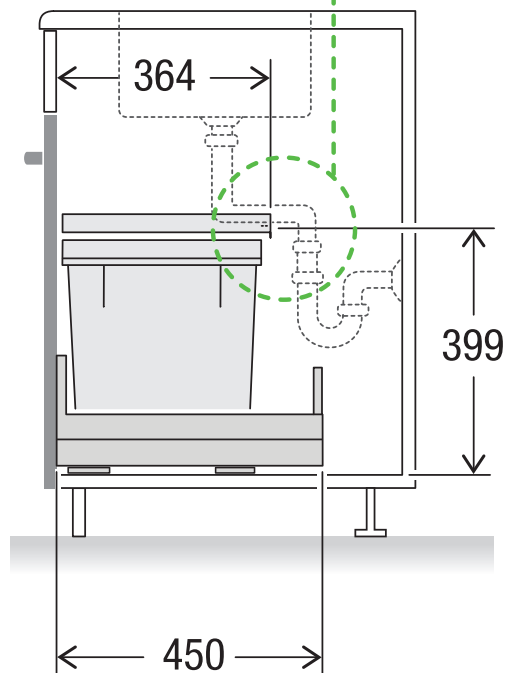
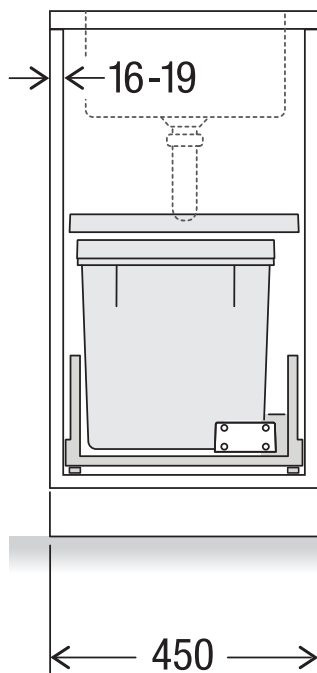
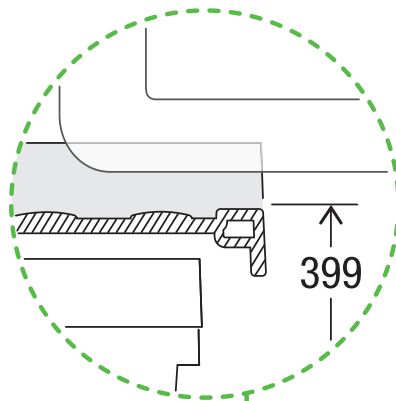
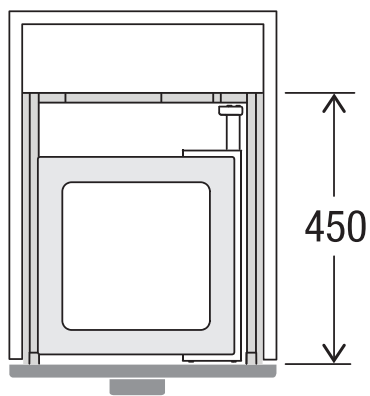

MÜLLEX

A. & J. Stöckli AG · Ennetbachstrasse 40 · CH-8754 Netstal
+41 55 645 55 80 · info@muellex.ch · muellex.ch