

X55 L5 Basic

Art. n° 80.50.301

**Système de tri de déchets
extractible pré-existant**

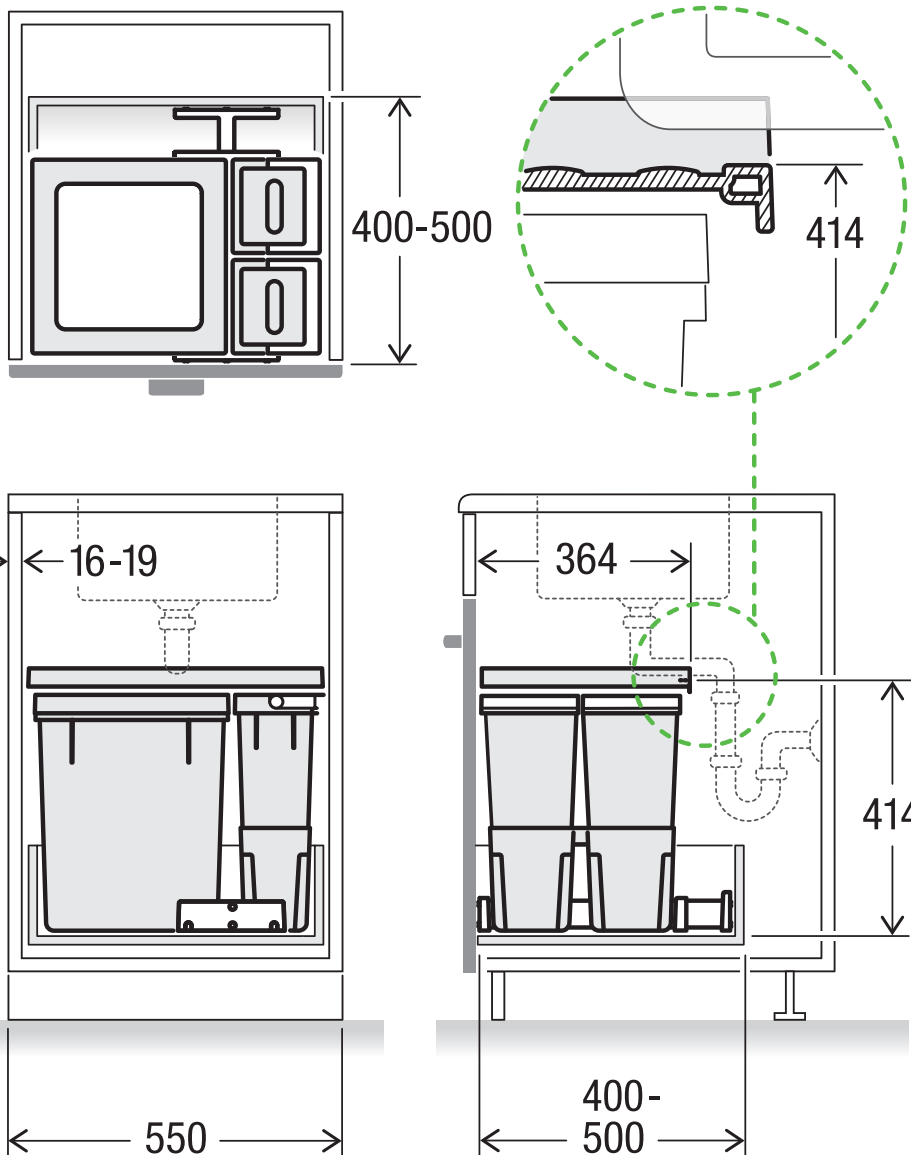

MÜLLEX

A. & J. Stöckli AG · Ennetbachstrasse 40 · CH-8754 Netstal
+41 55 645 55 80 · info@muellex.ch · muellex.ch