

COMFORT 35/5/4/4

Art.-Nr. 4950.40.992

**Abfalltrennsystem für
System mit Rollschubauszug**

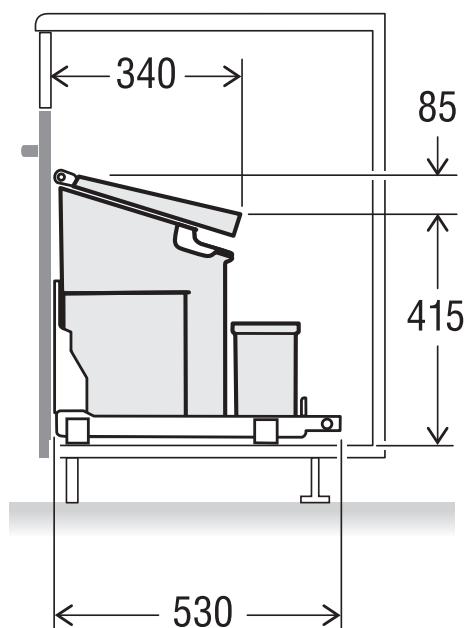
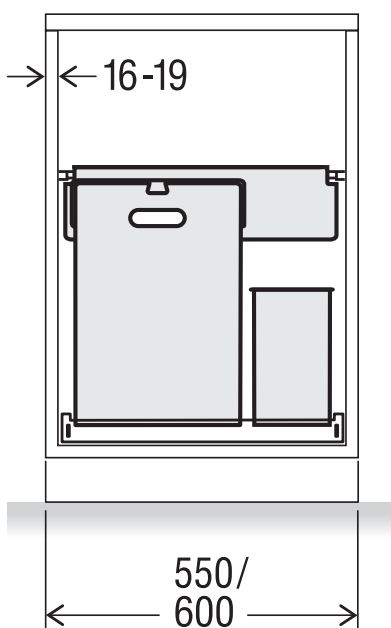
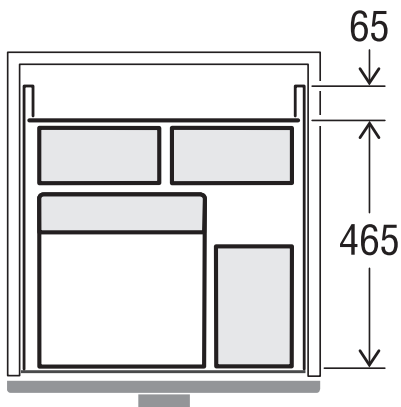

MÜLLEX

A. & J. Stöckli AG · Ennetbachstrasse 40 · CH-8754 Netstal
+41 55 645 55 80 · info@muellex.ch · muellex.ch