

# Réceptier de tri de déchets X60 M5

Art. n° 80.51.402

**Système extractible pré-existant**

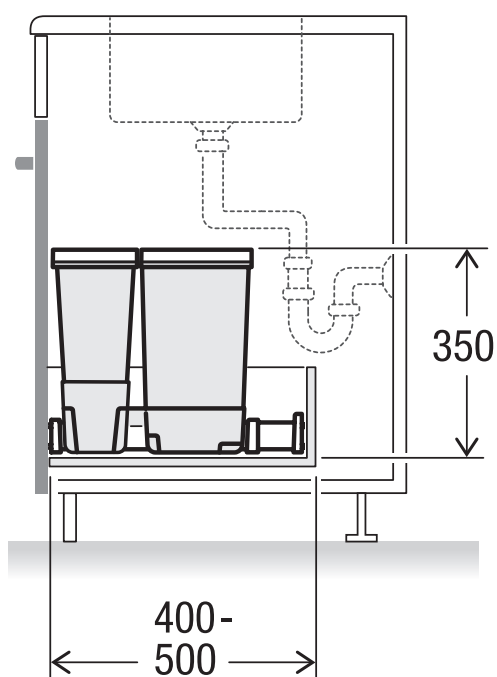
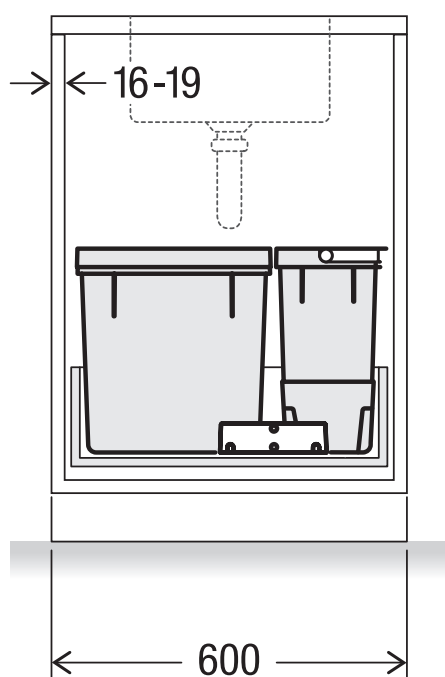
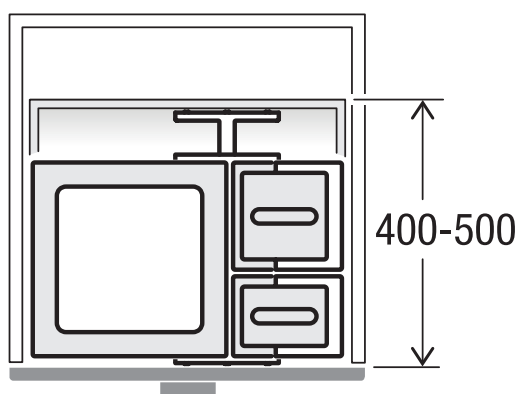

**MÜLLEX**

A. & J. Stöckli AG · Ennetbachstrasse 40 · CH-8754 Netstal  
+41 55 645 55 80 · info@muellex.ch · muellex.ch