

D40 L3

Art. n° 80.71.001

**Système de tri de déchets pour
portes tournantes**

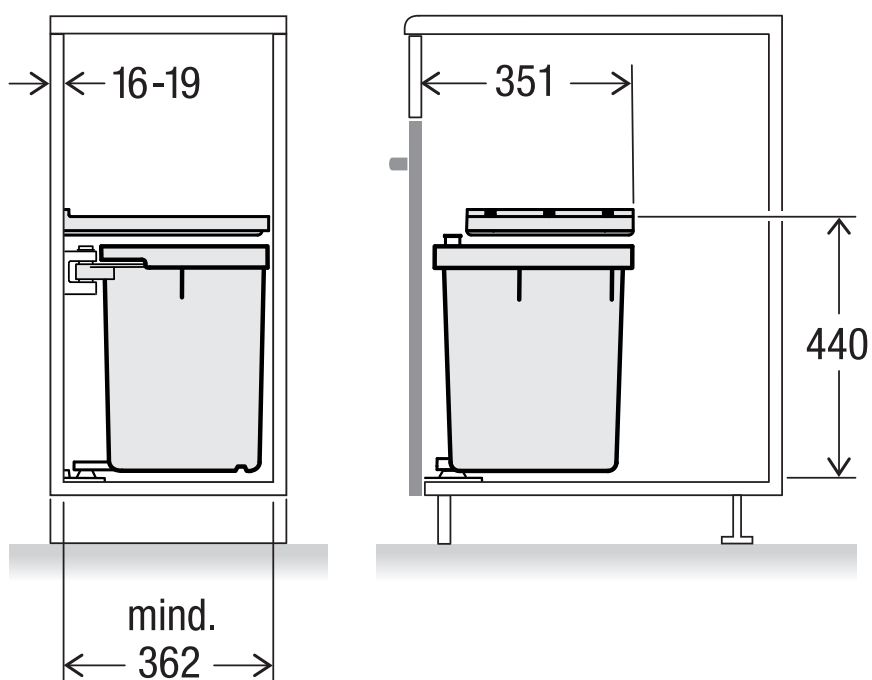
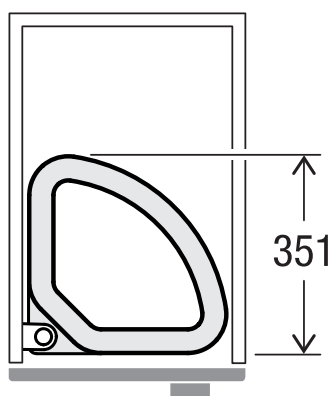

MÜLLEX

A. & J. Stöckli AG · Ennetbachstrasse 40 · CH-8754 Netstal
+41 55 645 55 80 · info@muellex.ch · muellex.ch