

# X90 L6 Basic

Art. n° 80.50.601

**Système de tri de déchets  
extractible pré-existant**

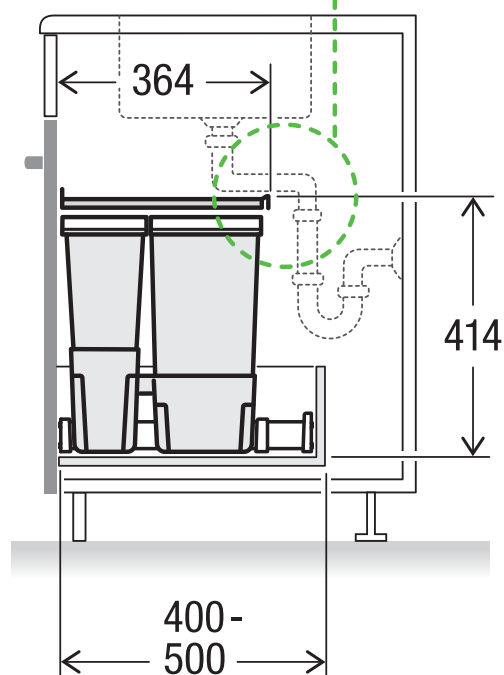
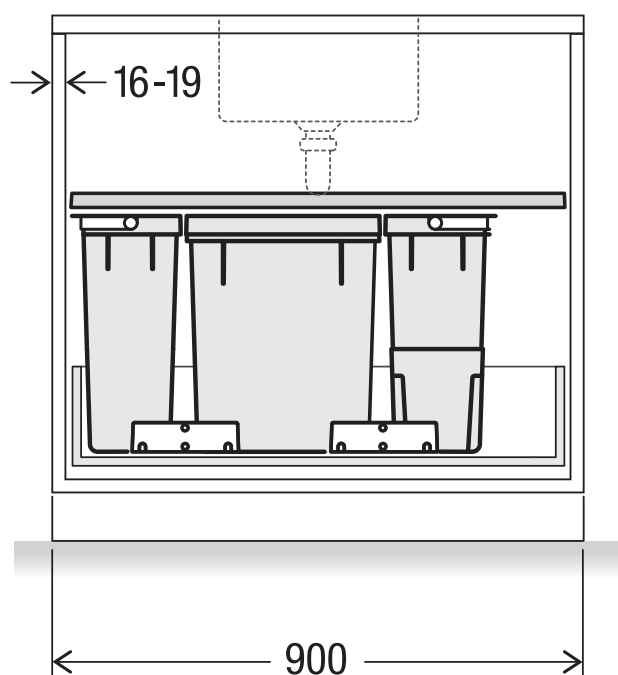
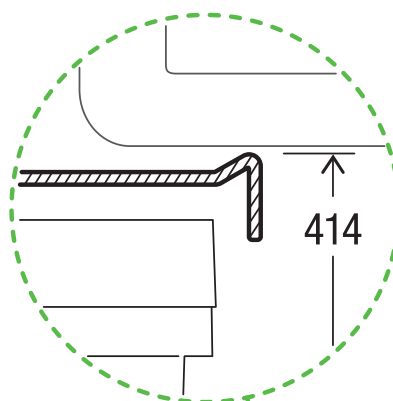
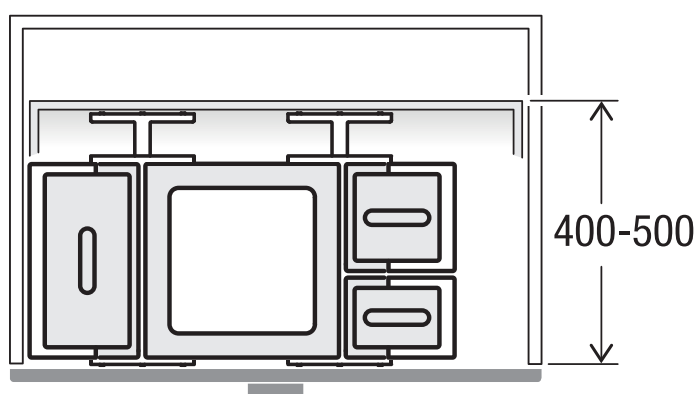

**MÜLLEX**

A. & J. Stöckli AG · Ennetbachstrasse 40 · CH-8754 Netstal  
+41 55 645 55 80 · info@muellex.ch · muellex.ch