

Réceptier de tri de déchets X60 L5

Art. n° 80.51.401

Système extractible pré-existant

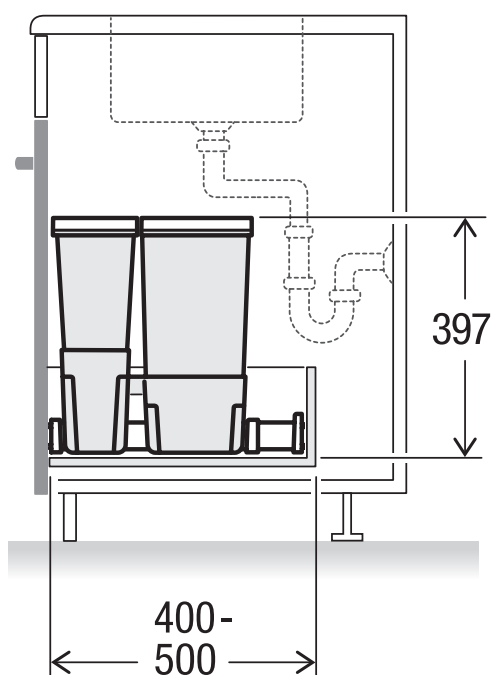
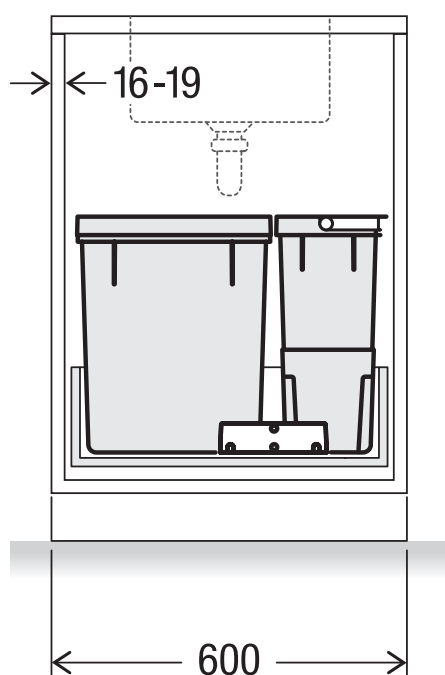
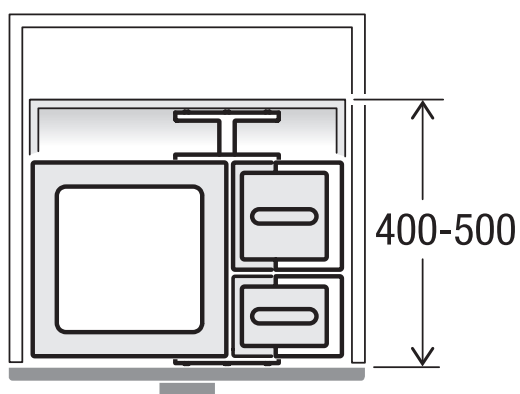

MÜLLEX

A. & J. Stöckli AG · Ennetbachstrasse 40 · CH-8754 Netstal
+41 55 645 55 80 · info@muellex.ch · muellex.ch