

Komplettschubkasten 40 Pro

Art.-Nr. 80.61.001

**Abfalltrennsystem mit
Zargenführungssystem**

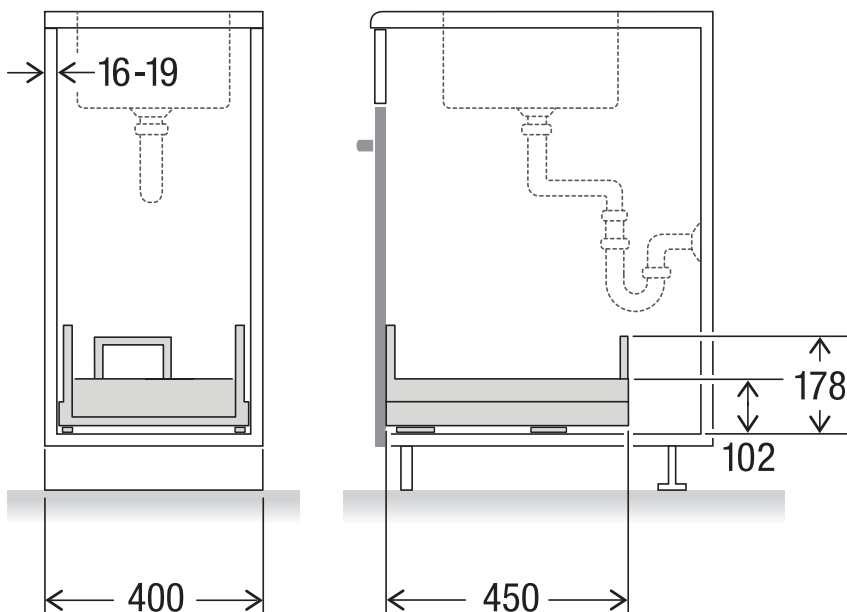
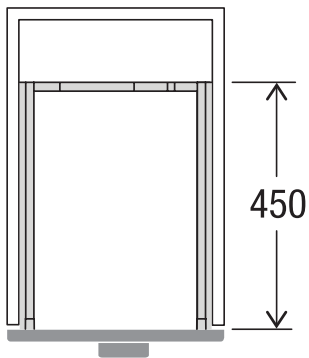

MÜLLEX

A. & J. Stöckli AG · Ennetbachstrasse 40 · CH-8754 Netstal
+41 55 645 55 80 · info@muellex.ch · muellex.ch