

Spanlattenschrauben
Vis pour panneau d'aggloméré
Vite per pannelli di truciolato
Pan Chipboard Screw

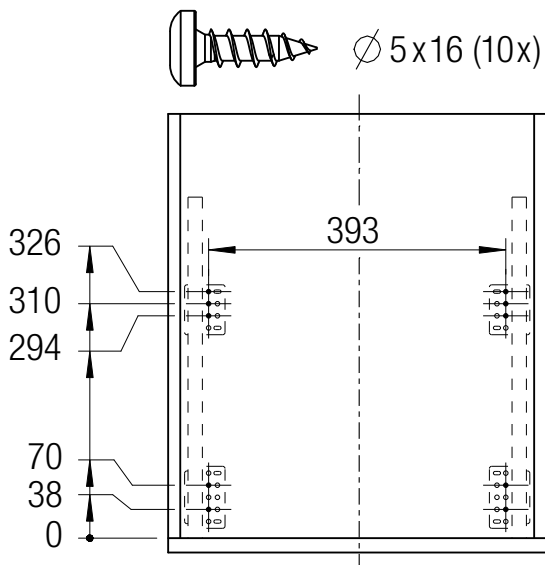
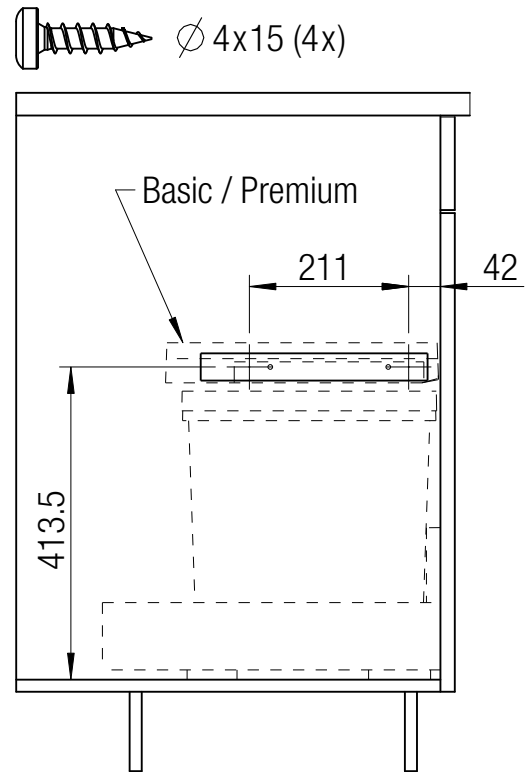
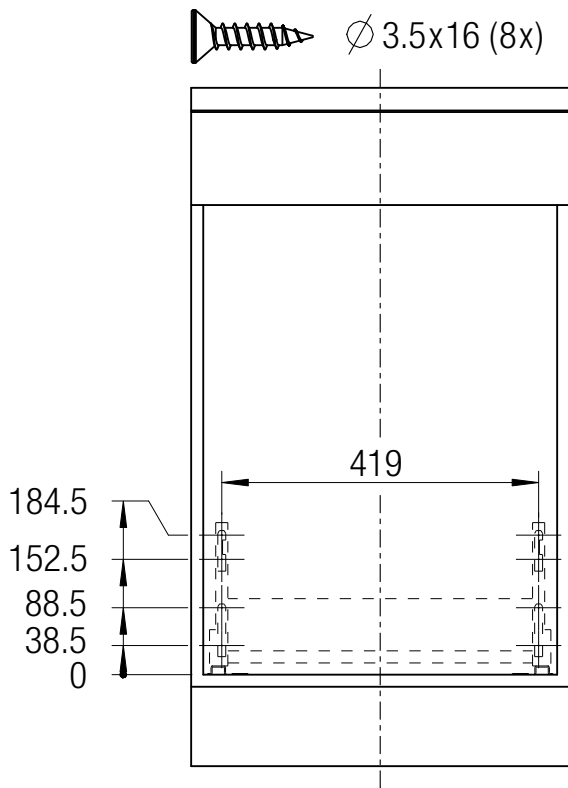

Bohrbild, Komplettschubkasten 50 Pro, Höhe M
Dessin de perçage, tiroir complet 50 Pro, Hauteur M
Disegno di foratura, cassetto preassemblato 50 Pro, Altezza M
Drilling drawing, pre-assembled drawer 50 Pro, Height M

Scale 1:10	Created	04.04.2024	proE
	Modified	04.04.2024	proE
Format A4			
	State	in Arbeit	
Drawing-No. / File-Name		Index	
1003747		-.1	