

# D40 M3

Art. n° 80.71.002

**Système de tri de déchets pour  
portes tournantes**

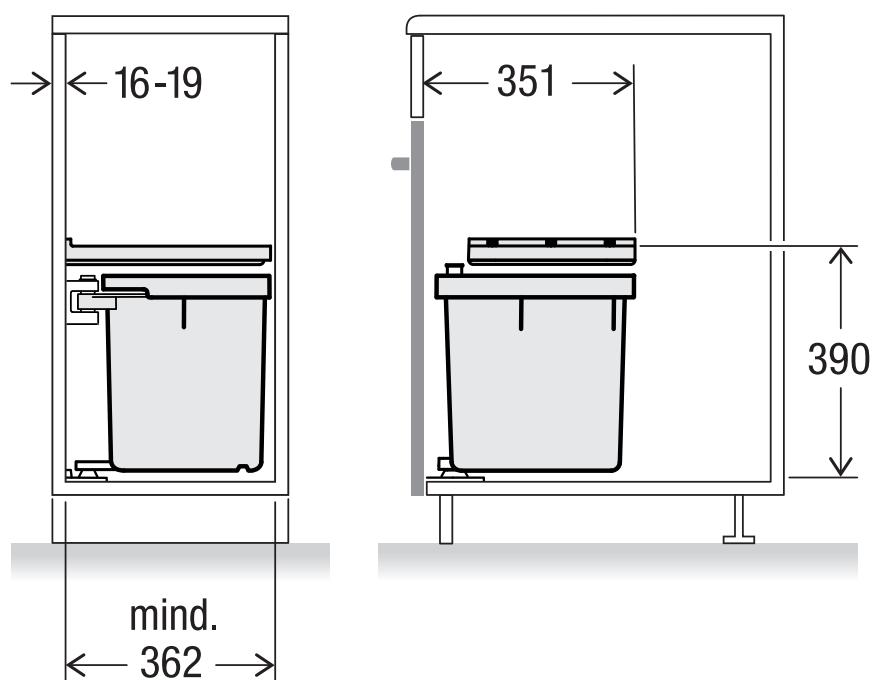
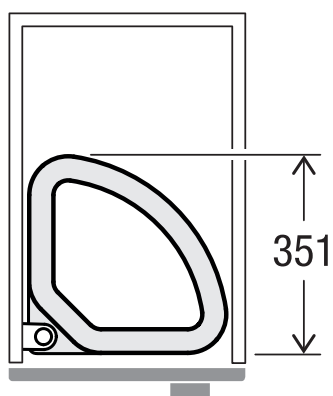

**MÜLLEX**

A. & J. Stöckli AG · Ennetbachstrasse 40 · CH-8754 Netstal  
+41 55 645 55 80 · info@muellex.ch · muellex.ch