

Waste separation container X45 L35

Art. No. 80.51.101

System for pre-existing rails

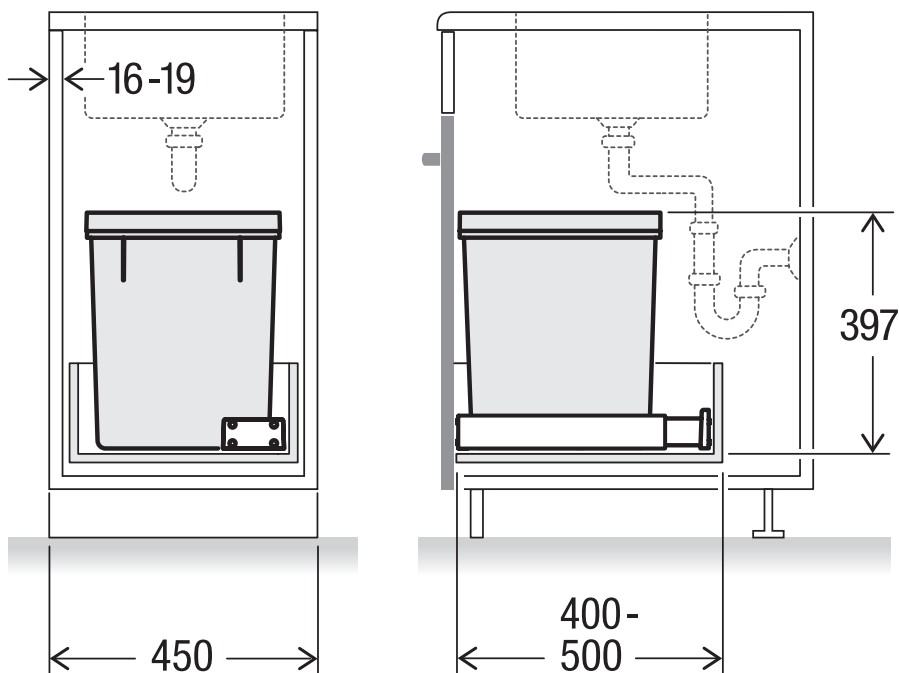
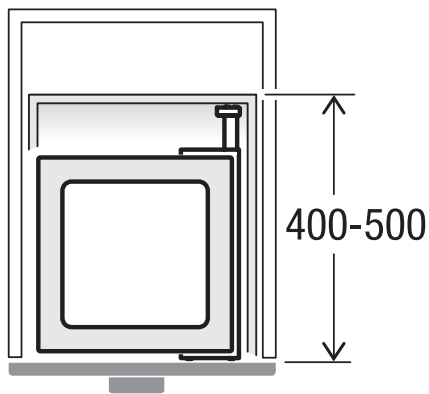

MÜLLEX

A. & J. Stöckli AG · Ennetbachstrasse 40 · CH-8754 Netstal
+41 55 645 55 80 · info@muellex.ch · muellex.ch